

Article number: 6041651320030

Description: Clamping plate for belts HTD 8M 30

Measures

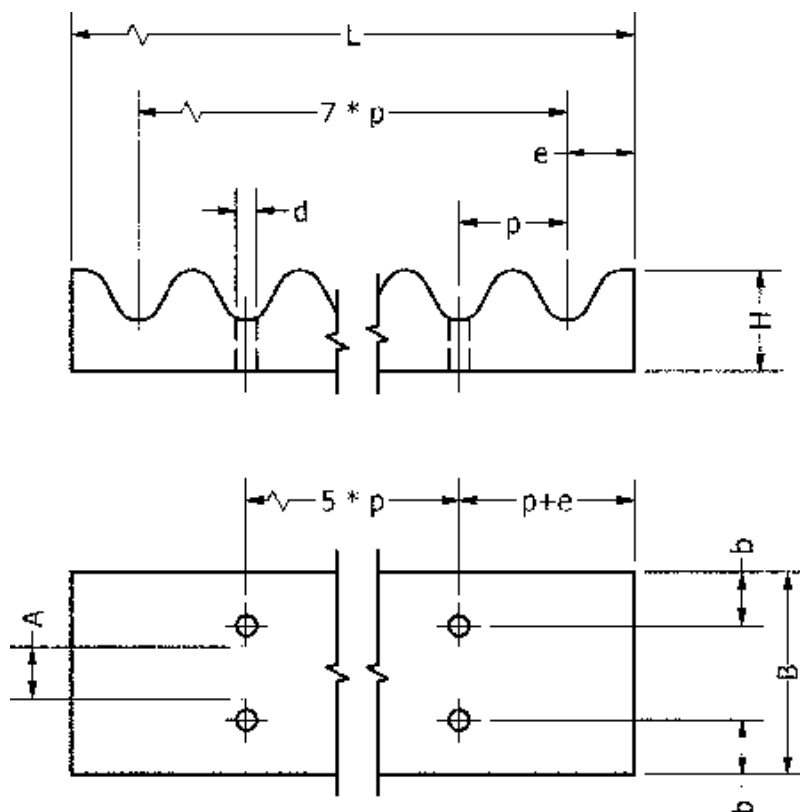

= -	b = 8
= -	B = 55
= -	d = 9
= -	e = 5
= -	H = 15
= -	L = 66
= -	
A = 30	